



Signaletik  
Segnaletica  
Signaletique

LED EDGE LIT SIGNS

# SOLED

LED EDGE LIT SIGNS



# VISION

MODULAR SIGN SYSTEMS & WAY FINDING SOLUTIONS

[www.vink.ch](http://www.vink.ch)

[info@vink.ch](mailto:info@vink.ch)

**EIN BEZAUBERNDEN ZUSAMMENSPIEL** ZWISCHEN LED BELEUCHTUNG  
UND ARCHITEKTUR

**UN'AFFASCINANTE INTESA** TRA ILLUMINAZIONE LED  
ED ARCHITETTURA

**UNE INTERACTION FASCINANTE** ENTRE L'ÉCLAIRAGE LED  
ET UN DESIGN ARCHITECTURAL





Die LED's sind in verschiedener Hinsicht den traditionellen Beleuchtungen überlegen und sind äusserst vielseitig. **Der geringe Energieverbrauch, ihre Langlebigkeit und ihre Funktion ohne Unterhalt, machen sie sehr ökologisch.** Die LED Beleuchtung ist, wie Ihre Quelle, einfach und effizient für die neuen Konzepte der Signalisation, was man bis vor kurzer Zeit kaum geglaubt hätte.

In diverse aspetti i LED sono considerati superiori e versatili alle illuminazioni tradizionali. **Lo scarso consumo d'elettricità, la longevità ed il suo funzionamento senza manutenzione li rendono ecologici.** L'illuminazione LED, come la sua sorgente, è semplice ed efficace per nuovi concetti di segnaletica, cosa che fino a breve tempo non si poteva dire.

Les LED sont supérieurs aux sources de lumière traditionnelles sous divers angles et ils sont particulièrement polyvalents. **Leur faible consommation électrique, leur durabilité et leur fonctionnement sans entretien les rendent particulièrement économiques.** L'éclairage LED est dès lors l'idéal comme source de lumière simple et efficace pour les nouveaux concepts de signalisations, ce qui était impensable il n'y a pas longtemps encore.

BELEUCHTETE SCHILDER | CARTELLI ILLUMINATI | EINSEIGNES ILLUMINÉES  
 ARCHITEKTONISCHE BELEUCHTUNG | ILLUMINAZIONE ARCHITETTONICA | ILLUMINATION ARCHITECTURAL  
 BELEUCHTETE WERBUNG | PUBBLICITÀ ILLUMINATA | PUBLICITÉ ILLUMINÉ  
 FIRMENIMAGE | IDENTITÀ MARCA | ESPRIT D'ENTREPRISE  
 LEITWEGE IM INNENBEREICH | PERCORSO SEGNALETICO | SIGNALISATION INTÉRIEUR  
 FLUCHTWEG-SIGNALISATION | SEGNALETICA VIA DI SCAMPO | SIGNALISATION CHEMIN DE FUITE  
 PIKTOGRAMME | PITTOGRAMMI | PITTOGRAMMES

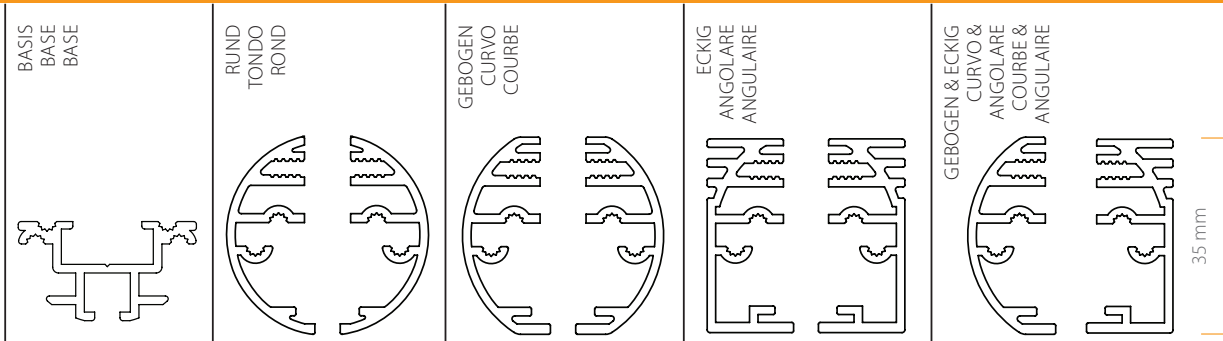

Cosign erweitert ihr LED Sortiment welche einen neuen Standard für Funktionalität und Design in der Werbeindustrie setzen. LED's stellen zahlreiche kreative Design-Optionen zu Verfügung auf Grund einer Vielzahl von Farben, kompakte Masse und flexiblem Modulen.

Cosign estende il loro sortimento di LED i quali rendono un nuovo standard per flessibilità e design nel mondo della pubblicità. I LED mettono a disposizione numerosi opzioni di design fondamento di colori, dimensioni compatte e moduli flessibili.

COSIGN ne cesse d'étendre sa gamme de produits LED qui révolutionnent les normes en matière de fonctionnalité et de design dans l'industrie de la signalisation. Les LED offrent d'innombrables possibilités de design créatives grâce à la multitude des couleurs disponibles, à leurs dimensions compactes et aux modules flexibles.



**SOLED besteht aus einem Set von runden, gebogenen und eckigen Aluminium Profilen welche einfach zu kombinieren sind. Mögliche Konfigurationen sind hängend, wandbefestigt, vorspringend oder Fahnenbefestigungen, Anschriftenverzeichnisse und Tischständer.**

**SOLED consiste di un set di profili in alluminio rotondi, curvi ed angolari i quali sono semplici da combinare. Possibili configurazioni sono pendenti, fissati ai muri, sporgenti o fissazioni bandiere, rubrica elenco e stand da tavola.**

**SOLED existe dans un set de profilés en aluminium rond, courbe et angulaire lesquels sont simple à combiner. Possibles configurations sont pendante, fixation au mur, avancé ou fixation banner et stand de table.**

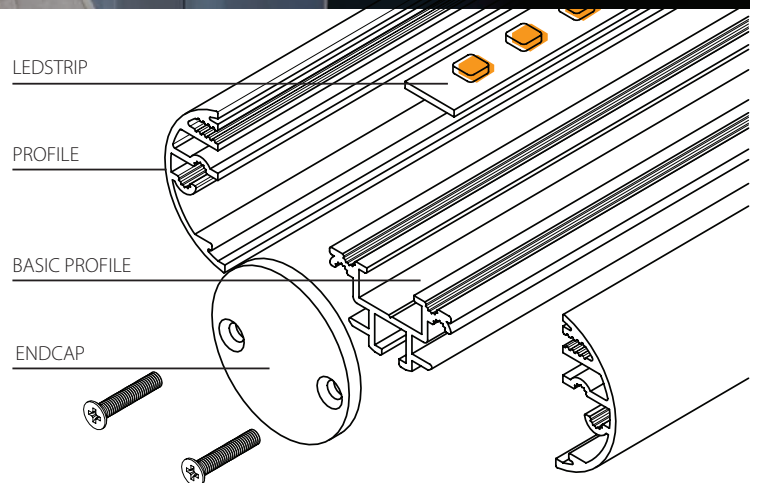



**ARCHITEKTONISCHES DESIGN / DESIGN ARCHITETTONICO / DESIGN ARCHITECTONIQUE**

Elegant / kompakt / slim line  
Elegante / compatto / slim line  
Élégant / compact / slim line

**HOCHERWERTIGE PROFILE / PROFILI DI ALTA QUALITÀ / PROFILES HAUTE QUALITÉ**

- Rund, gebogen und eckig silber eloxiert oder fabrikfertige Profile  
Tondi, curvi o angolari in argento anodizzato o profili prefabbricati  
Rond, courbe ou angolaire en argent anodié ou profiles préfabriqué

**EINFACH ZU MONTIEREN / MONTAGGIO SEMPLICE / MONTAGE FACILE**

LED strips mit einem doppelseitigem Tape am Profil montiert  
LED strips con tape bilaterale montato sul profilo  
LED strips avec tape double face monté sur le profile

**FLEXIBEL / FLESSIBILE / FLEXIBLE**

Geeignet für hinterleuchtete Panels (in Glas oder Acryl)  
mit einer Dicke zwischen 8 und 12 mm, dank dem angepassten Design  
mit wechselbaren Schrauben (in Bezug auf die Dicke des Panels)

Adatto per panel retro illuminati (in vetro o acrilico)  
spessore da 8 a 12 mm, grazie al design adattato con viti cambiabili  
(dipende lo spessore del panel)



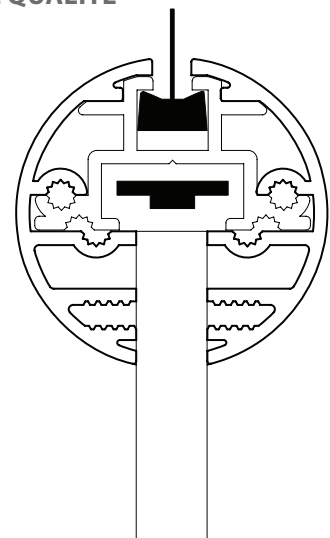

Approprié pour panels retro illuminés (en verre ou acrylique)  
d'épaisseur de 8 à 12 mm, grâce au design adapté avec visse changeables  
(dépendent du l'épaisseur du panel)





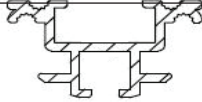

SOLED

**SOLED** Innenbeschilderung modulierbar – beleuchtet  
 Segnaletica interna modulabile – illuminata  
 Signalétique intérieure modulable – illuminée

Artikel Articolo Article	Artikel-nr. No d'articolo No.d'article	Beschreibung Descrizione Description	Masse/Anzahl Dimensione/Numero Dimensions/Nombre		Preis per Meter/CHF Prezzo al Metro/CHF Prix au mètre/CHF
<b>ALUMINIUM PROFILE / PROFILI ALLUMINO / PROFILES ALUMINIUM</b>					
SOL1000.B	551371	Rahmen brut Cornice brut Chassis brut	5m 5m 5m		7.90
SOL1000.R	551372	Profil halbrund brut Profilo semirotondo brut Profilé demi-rond brut	5m 5m 5m		7.80
SOL2000.R	551373	Profil halbrund eloxiert Profilo semirotondo anodizzato Profilé demi-rond anodisé	5m 5m 5m		11.10
SOL1000.C	551374	Profil gerundet brut Profilo arrotondato brut Profilé demi-galbé brut	5m 5m 5m		8.40
SOL2000.C	551375	Profil gerundet eloxiert Profilo arrotondato anodizzato Profilé demi-galbé anodisé	5m 5m 5m		11.90
SOL1000.S	551376	Profil halbeckig brut Profilo semiangolare brut Profile semi-carré brut	5m 5m 5m		10.60
SOL2000.S	551377	Profil halbeckig eloxiert Profilo semiangolare anodizzato Profile semi-carré anodisé	5m 5m 5m		15.00

Artikel Articolo Article	Artikel-nr. No d'articolo No.d'article	Beschreibung Descrizione Description	Masse Dimensione Dimensions	Anzahl Numero Nombre	Preis per Stück/CHF Preis per Stück/CHF Prix par pièce/CHF
--------------------------------	--	--	-----------------------------------	----------------------------	--

## ENDBEARBEITUNG / FINITURA / FINITIONS

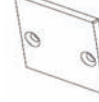
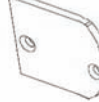
SOLCAP08.R	551378	für rundes Profil (R) per profilo tondo (R) pour profil rond (R)	8mm 8mm 8mm	10 Stück 10 pezzi 10 pieces		92.00
SOLCAP12.R	551379	für rundes Profil (R) per profilo tondo (R) pour profil rond (R)	12mm 12mm 12mm	10 Stück 10 pezzi 10 pieces		95.00
SOLCAP08.C	551380	für gerundetes Profil (C) per profilo arrotondato (C) pour profil demi-galbé (C)	8mm 8mm 8mm	10 Stück 10 pezzi 10 pieces		92.00
SOLCAP12.C	551381	für gerundetes Profil (C) per profilo arrotondato (C) pour profil demi-galbé (C)	12mm 12mm 12mm	10 Stück 10 pezzi 10 pieces		95.00
SOLCAP08.S	551382	für eckiges Profil (S) per profilo angolare (S) pour profil angulaire (S)	8mm 8mm 8mm	10 Stück 10 pezzi 10 pieces		92.00
SOLCAP12.S	551383	für eckiges Profil (S) per profilo angolare (S) pour profil angulaire (S)	12mm 12mm 12mm	10 Stück 10 pezzi 10 pieces		95.00
SOLCAP08.SC	551384	kombiniert für gerundetes + eckiges Profil combinata per profilo arrotondato + angolare combinaison carré + galbé	8mm 8mm 8mm	10 Stück 10 pezzi 10 pieces		92.00
SOLCAP12.SC	551385	kombiniert für gerundetes + eckiges Profil combinata per profilo arrotondato + angolare combinaison carré + galbé	12mm 12mm 12mm	10 Stück 10 pezzi 10 pieces		95.00



Artikel Articolo Article	Artikel-nr. No d'articolo No.d'article	Beschreibung Descrizione Description	Masse Dimensione Dimensions	Anzahl Numero Nombre	Preis per Stück/CHF Preis per Stück/CHF Prix par piece/CHF
<b>AUFHÄNGESYSTEME / SOSPENSIONE / SYSTEM DE SUSPENSION</b>					
APC4101	551389	Aufhängesystem KONISCH – 2 x Clip + Stahldraht Sospensione CONICA – 2 x clip + filo di acciaio System de suspension CONIQUE – 2 x clip + fil acier		1 Set 1 set 1 set	17.60
APC4102	551390	Aufhängesystem INOX – 2 x Clip + Stahldraht Sospensione INOX – 2 x clip + filo di acciaio System de suspension INOX – 2 x clip + fil acier		1 Set 1 set 1 set	16.60
APC4103	551391	Aufhängesystem ECO – 2 x Clip + Stahldraht Sospensione ECO – 2 x clip + filo di acciaio System de suspension ECO – 2 x clip + fil acier		1 Set 1 set 1 set	14.50
APC3000S	551388	Clip für Aufhängung schwarz Clip per sospensione nero Clip de suspension noir		50 Stück 50 pezzi 50 pieces	18.90
SOLBRAC08	551386	Halterung eloxiert natur für alle Profile Supporto anodizzato naturale per tutti profili Patères anodisé naturel tout les profiles	8mm 8mm 8mm		11.00
SOLBRAC12	551387	Halterung eloxiert natur für alle Profile Supporto anodizzato naturale per tutti profili Patères anodisé naturel tout les profiles	12mm 12mm 12mm		11.00

Artikel Articolo Article	Artikel-nr. No d'articolo No.d'article	Beschreibung Descrizione Description	Masse Dimensione Dimensions	Preis per Rolle/CHF Prezzo al rotolo/CHF Priix par rouleau/CHF
<b>LED / LED / LED</b>				
LEDSTRIP	551392	Flexibles LED Band 300 LED's / Rolle, 5000 x 8mm – 120° Ecke – 12V DC input Strom einfarbig – LED's Band kann geschnitten werden – Klebeband 3M 50.000 Stunden – Ausgang Licht: 600 Lum. 300 x 120mcd  Nastro flessibile LED 300 LED / rotolo, 5000 x 8mm – 120° angolo – 12V DC input elettricità monocolore – nastro LED puo essere tagliato – nastro adesivo 3M 50.000 ore – uscita illuminazione: 600 Lum. 300 x 120mcd  Bande de LED flexible 300 LED's / rouleau, 5000 x 8mm – 120 degrés sous angle – 12V DC input voltage – mono couleur - possibilité de couper tout les 3 LED's Bande adhésive 3M – 50 000 heures - Sortie lumière: 600 Lum. 300x1200mcd	5lm / Rolle  5 metri / rotolo  5 mètres par rouleau	290.00
LEDSTRIPHO	551393	Flexibles LED Band 390 LED's / Rolle, 5000 x 8mm – 120° Ecke – 12V DC input Strom einfarbig – LED's Band kann geschnitten werden – Klebeband 3M 50.000 Stunden – Ausgang Licht: 1950 Lum. 390 x 400mcd  Nastro flessibile LED 390 LED / rotolo, 5000 x 8mm – 120° angolo – 12V DC input elettricità monocolore – nastro LED puo essere tagliato – nastro adesivo 3M 50.000 ore – uscita illuminazione: 1950 Lum. 300 x 400mcd  Bande de LED flexible 300 LED's / rouleau, 5000 x 8mm – 120 degrés sous angle – 12V DC input voltage – mono couleur - possibilité de couper tout les 3 LED's Bande adhésive 3M – 50 000 heures - Sortie lumière: 1950 Lum. 300x400mcd	5lm / Rolle  5 metri / rotolo  5 mètres par rouleau	393.00

Artikel Articolo Article	Artikel-nr. No d'articolo No.d'article	Beschreibun Descrizione Description	Masse Dimensione Dimensions	Anzahl Numero Nombre	Preis per Stück/CHF Preis per Stück/CHF Prix par piece/CHF
--------------------------------	--	---	-----------------------------------	----------------------------	--

## ADAPTORS + POWER CABLES

EUROPE		ADAPTOR	PLUG		
EU1.5A	551394	output 12V - 1.5A	CEE7/16	1	32.00
EU3.5A	551395	output 12V - 3.5A	CEE7/7	1	34.00
EU5.0A	551396	output 12V - 5A	CEE7/7§	1	36.00
U.S.A.		ADAPTOR	PLUG		
US1.5A	551397	output 12V - 1.5A	NEMA 5-15	1	32.00
US3.5A	551398	output 12V - 3.5A	NEMA 5-15	1	34.00
US5.0A	551399	output 12V - 5A	NEMA 5-15	1	36.00

# VISIGN

ARCHITECTURAL SIGNAGE

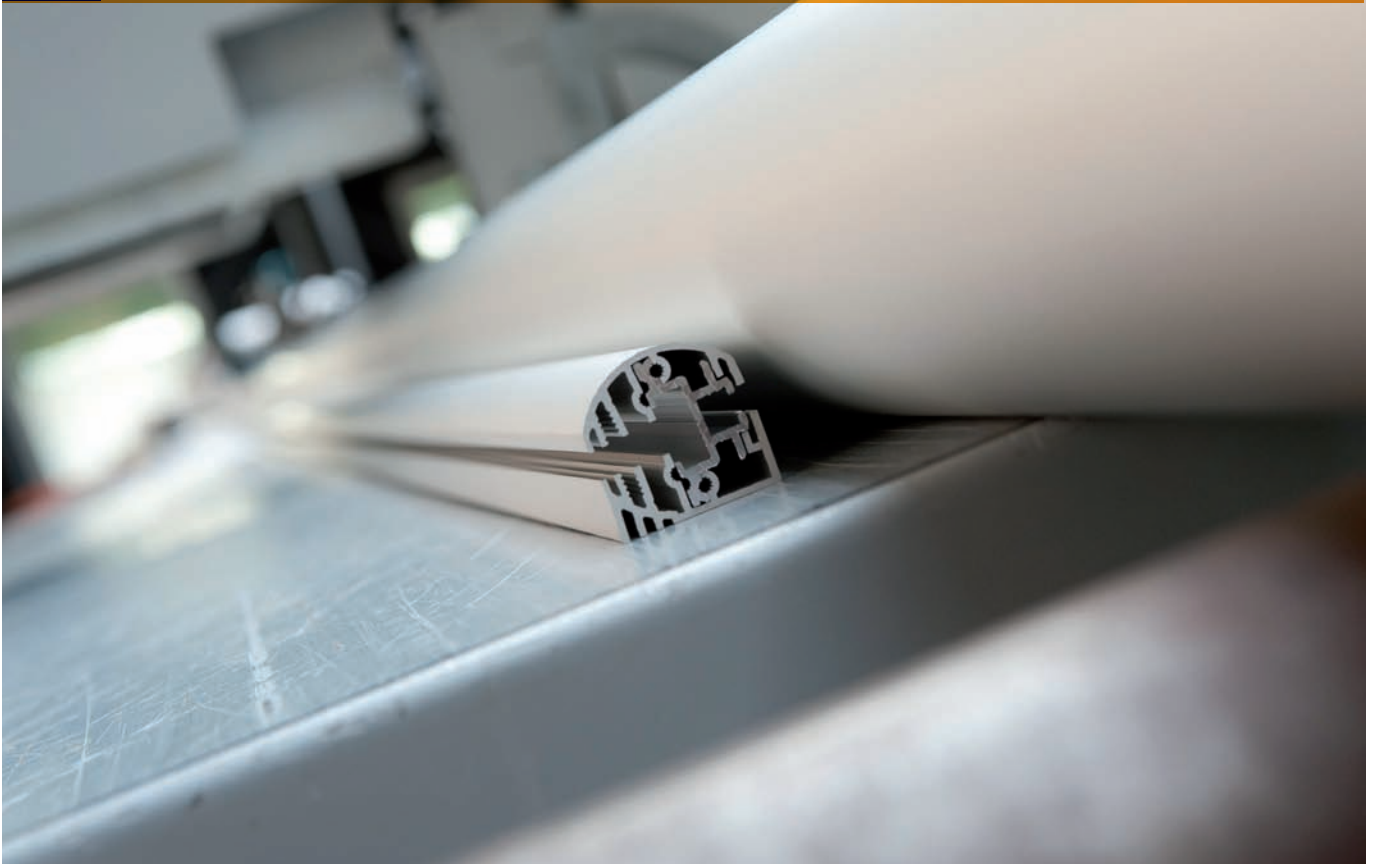

[www.vink.ch](http://www.vink.ch)



[www.vink.ch](http://www.vink.ch)

[info@vink.ch](mailto:info@vink.ch)